

6

5

4

3

2

1

D

D

C

C

B

B

A

A

REVISION RECORD			
LTR	ECO NO:	APPROVED:	DATE:

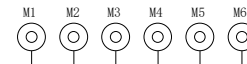
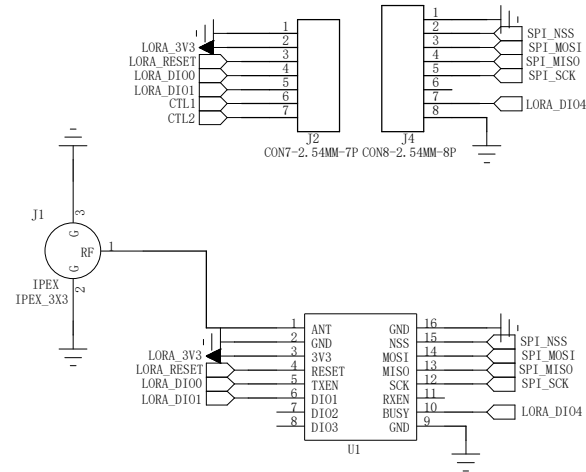

COMPANY:			
TITLE: Ra-01转接板			
CODE:	SIZE: B	DRAWING NO:	REV: 2.0
SCALE:		SHEET: 1 OF 1	

DRAWN:	DATED:
CHECKED:	DATED:
QUALITY CONTROL:	DATED:
RELEASED:	DATED: